

GL-N12 SERIES

NEW

Low Price Square-shaped Inductive Proximity Sensor

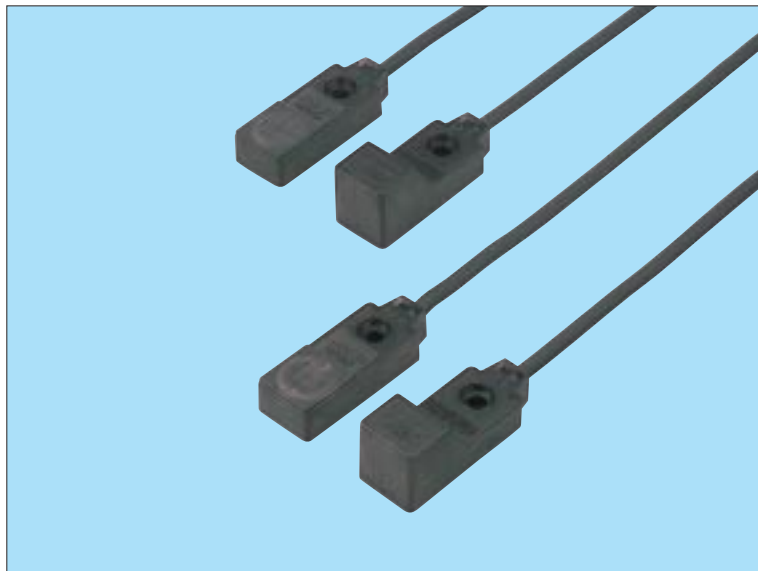

Wide Variety with Total Cost Reduction!

CE Marked
Conforming to EMC Directive

Exclusive Mounting Bracket is Needless

The **GL-N12** series can be reliably fixed even without an exclusive mounting bracket as a boss is provided on the bottom face of the sensor to prevent rotation.

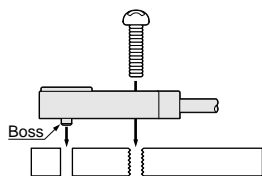

Low Price

The **GL-N12** series is recommended to large volume users for cost reduction.

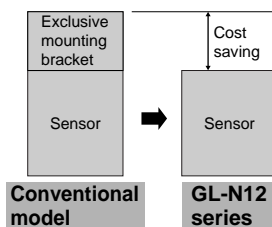

Cost saving is achieved as the exclusive mounting bracket is not required.

The **GL-N12** series is available in units of ten sensors.

Wide Variation

A wide variety of 16 types, front sensing type/top sensing type, normally open type/normally closed type, as well as, different frequency type, PNP output type, etc., is available.

You can choose from the vastly increased variety to suit your application.

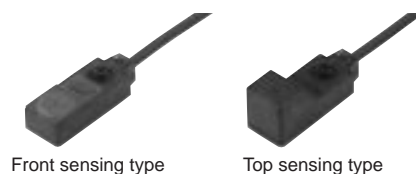

Long Sensing Range

It achieves a sensing range of 4mm with a 12mm square-size sensing part. It can reliably detect an object even if its position varies slightly.

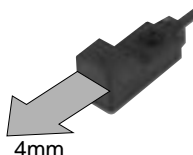

Waterproof

Since the sensor has IP67 protection, it can withstand water splashes.

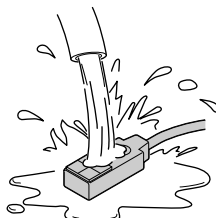

APPLICATIONS

Confirming shutting/opening of door

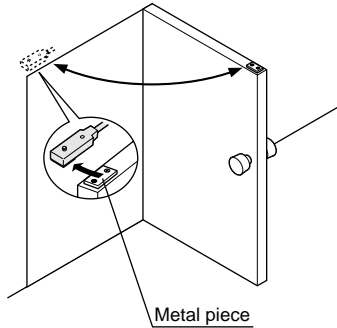

Detecting rolling coins

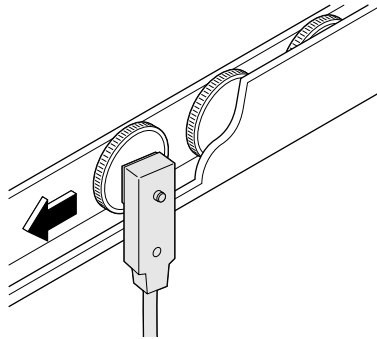

Detecting metal parts on a feeder

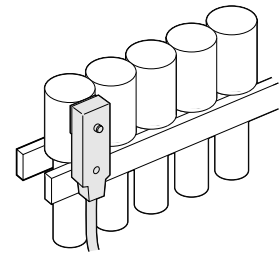

ORDER GUIDE

Type	Appearance (mm)	Sensing range (Note 1)	Model No. (Note 2)	Output	Output operation		
Boss type			GL-N12F X 10	NPN open-collector transistor	Normally open		
			GL-N12FI X 10		Normally closed		
			GL-N12FB X 10	PNP open-collector transistor	Normally open		
			GL-N12FIB X 10		Normally closed		
			GL-N12F-P X 10	NPN open-collector transistor	Normally open		
			GL-N12FI-P X 10		Normally closed		
	GL-N12FB-P X 10		PNP open-collector transistor	Normally open			
	GL-N12FIB-P X 10			Normally closed			
	Top sensing				GL-N12H X 10	NPN open-collector transistor	Normally open
					GL-N12HI X 10		Normally closed
					GL-N12HB X 10	PNP open-collector transistor	Normally open
					GL-N12HIB X 10		Normally closed
GL-N12H-P X 10		NPN open-collector transistor			Normally open		
GL-N12HI-P X 10					Normally closed		
GL-N12HB-P X 10	PNP open-collector transistor	Normally open					
GL-N12HIB-P X 10		Normally closed					

Notes: 1) The maximum operation distance stands for the maximum distance for which the sensor can detect the standard sensing object. The stable sensing range stands for the sensing range for which the sensor can stably detect the standard sensing object even if there is an ambient temperature drift and/or supply voltage fluctuation.
 2) 'I' in the model No. indicates a different frequency type (custom-order product).

NOTE: Low price square-shaped inductive proximity sensors (GL-N12 series) are available in units of ten.

Without boss type (Front sensing type, NPN output type and normally open type only) **Units of ten**

The without boss type is also available. (Standard: boss type)

Model No.: GL-12F X 10 (front sensing type)

MS-GL12 X 10 (sensor mounting bracket)

GL-N12

SPECIFICATIONS

Item	Model No.	Type	Boss type (Note 1)							
			NPN output				PNP output			
			Front sensing		Top sensing		Front sensing		Top sensing	
			Different frequency		Different frequency		Different frequency		Different frequency	
	Normally open	GL-N12FX10	GL-N12FI X10	GL-N12HX10	GL-N12HI X10	GL-N12F-P X10	GL-N12FI-P X10	GL-N12H-PX10	GL-N12HI-P X10	
	Normally closed	GL-N12FBX10	GL-N12FIB X10	GL-N12HBX10	GL-N12HIB X10	GL-N12FB-P X10	GL-N12FIB-P X10	GL-N12HB-PX10	GL-N12HIB-P X10	
Max. operation distance (Note 2)		4 ± 0.5mm								
Stable sensing range (Note 2)		0 to 3mm								
Standard sensing object		Iron sheet 20 × 20 × 1mm								
Hysteresis		20% or less of operation distance								
Supply voltage		12 to 24V DC ± 10% Ripple P-P 10% or less								
Current consumption		10mA or less				15mA or less				
Output		NPN open-collector transistor • Maximum sink current: 100mA • Applied voltage: 30V DC or less (between output and 0V) • Residual voltage: 1V or less (at 100mA sink current) 0.4V or less (at 16mA sink current)				PNP open-collector transistor • Maximum source current: 100mA • Applied voltage: 30V DC or less (between output and +V) • Residual voltage: 1V or less (at 100mA source current) 0.4V or less (at 16mA source current)				
Utilization category		DC-12 or DC-13								
Max. response frequency		1.3kHz								
Operation indicator		Orange LED (lights up when the output is ON)								
Environmental resistance	Pollution degree	3 (Industrial environment)								
	Protection	IP67 (IEC)								
	Ambient temperature	- 10 to + 55°C, Storage: - 25 to + 70°C								
	Ambient humidity	45 to 85% RH, Storage: 35 to 95% RH								
	EMC	Emission: EN50081-2, Immunity: EN50082-2								
	Voltage withstandability	1,000V AC for one min. between all supply terminals connected together and enclosure								
	Insulation resistance	50MΩ, or more, with 250V DC megger between all supply terminals connected together and enclosure								
	Vibration resistance	10 to 55Hz frequency, 1.5mm amplitude in X, Y and Z directions for two hours each								
Shock resistance	1,000m/s ² (100G approx.) acceleration in X, Y and Z directions for three times each									
Sensing range variation	Temperature characteristics	Over ambient temperature range - 10 to + 55°C: within $\pm \frac{15}{10}$ % of sensing range at 20°C								
	Voltage characteristics	Within ± 2% for ± 10% fluctuation of the supply voltage								
Material		Enclosure: Polyallylate								
Cable		0.18mm ² 3-core cabtyre cable, 1m long								
Cable extension		Extension up to total 100m is possible with 0.3mm ² , or more, cable.								
Weight		20g approx.								

- Notes: 1) The without boss type is also available.
 The specifications are the same as for the boss type.
- 2) The maximum operation distance stands for the maximum distance for which the sensor can detect the standard sensing object.
 The stable sensing range stands for the sensing range for which the sensor can stably detect the standard sensing object even if there is an ambient temperature drift and/or supply voltage fluctuation.

I/O CIRCUIT AND WIRING DIAGRAMS

NPN output type

I/O circuit diagram

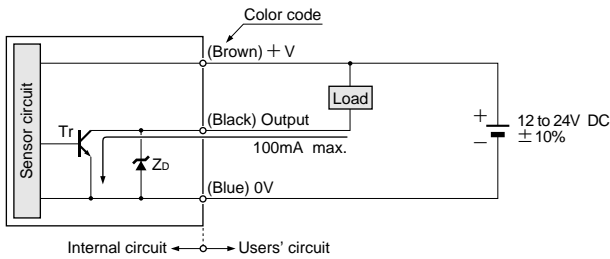

Symbols ... Zd: Surge absorption zener diode
Tr: NPN output transistor

Wiring diagram

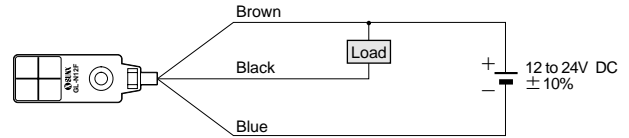

PNP output type

I/O circuit diagram

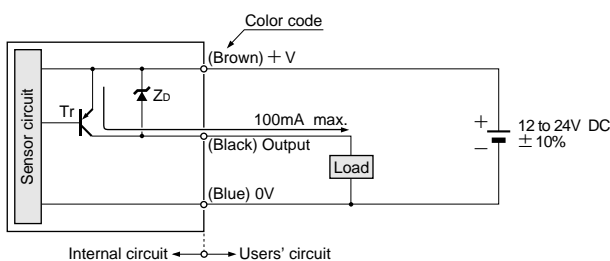

Symbols ... Zd: Surge absorption zener diode
Tr: PNP output transistor

Wiring diagram

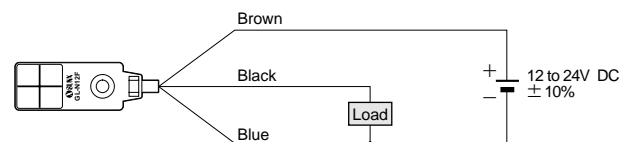

SENSING CHARACTERISTICS (TYPICAL)

Sensing field

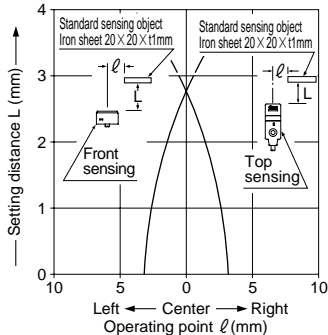

Correlation between sensing object size and sensing range

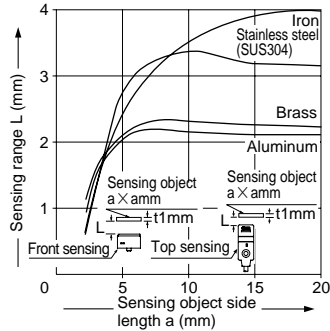

As the sensing object size becomes smaller than the standard size (iron sheet 20×20×1mm), the sensing range shortens as shown in the left figure.

GXL

GL-6

GL-8U

Amplifier Built-in Type
GL-18H/18HL

GL-N12

GX-U

GX-N

GX

Amplifier-separated Type
GA-10/GH

GL-N12

PRECAUTIONS FOR PROPER USE

Refer to P.836~ for general precautions.



This product is not a safety sensor. Its use is not intended or designed to protect life and prevent body injury or property damage from dangerous parts of machinery. It is a normal object detection sensor.

Mounting

- The tightening torque should be 0.5N·m or less.
- To mount the sensor with a nut, the mounting hole diameter should be ϕ 3.4mm. Further, the hole in which the boss is inserted should be ϕ 2.5mm and 3mm, or more, deep.

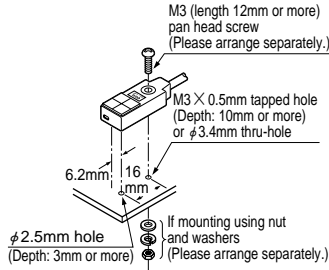

Influence of surrounding metal

- When there is a metal near the sensor, keep the minimum separation distance specified below.

GL-N12F□ × 10

(Unit: mm)

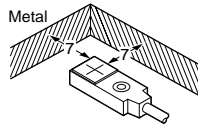
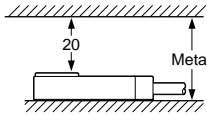

GL-N12H□ × 10

(Unit: mm)

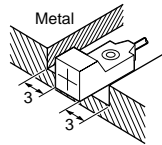
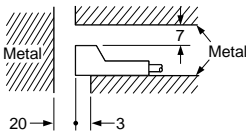

Mutual interference prevention

- When two or more sensors are installed in parallel or face to face, keep the minimum separation distance specified below to avoid mutual interference.

	GL-N12F□ × 10, GL-N12H□ × 10	GL-N12F□ × 10	GL-N12H□ × 10
	Between 'I' type and non 'I' type	Between two 'I' types or two non 'I' types	
A	0mm (Note 2)	25mm	
B	25mm	50mm	

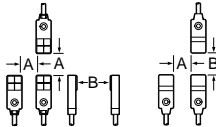

Notes: 1) 'I' in the model No. specifies the different frequency type.

2) Close mounting is possible for up to two sensors.

When mounting three sensors or more, at an equal spacing, in a row, the minimum value of dimension A should be 6.5mm.

Sensing range

- The sensing range is specified for the standard sensing object (iron sheet 20 × 20 × 1mm).

With a non-ferrous metal, the sensing range is obtained by

multiplying with the correction coefficient specified on the right. Further, the sensing range also change if the sensing object is smaller than the standard sensing object (iron sheet 20 × 20 × 1mm) or if the sensing object is plated.

Correction coefficient

Model No.	GL-N12F□ × 10 GL-N12H□ × 10
Iron	1
Stainless steel (SUS304)	0.79 approx.
Brass	0.56 approx.
Aluminum	0.53 approx.

Wiring

- The output is not incorporated with a short-circuit protection circuit. Do not connect it directly to a power supply or a capacitive load.

Others

- Do not use during the initial transient time (50ms) after the power supply is switched on.

DIMENSIONS (Unit: mm)

GL-N12F□ × 10 Sensor

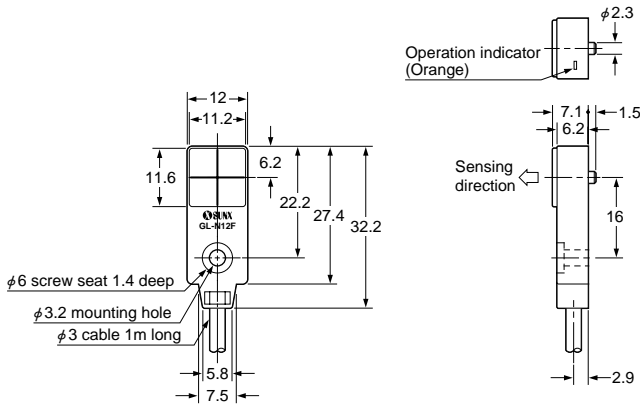

GL-N12H□ × 10 Sensor

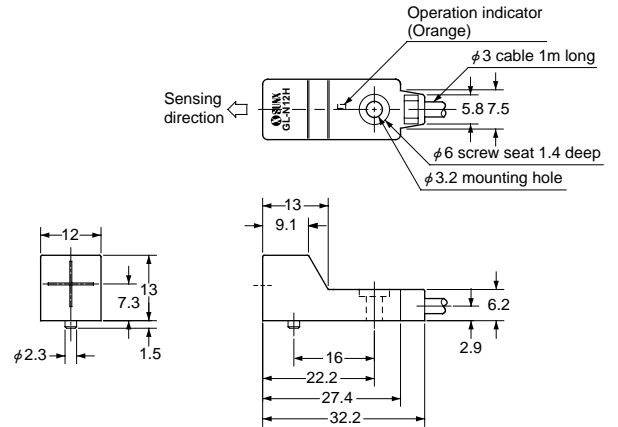

GL-12F × 10 Sensor

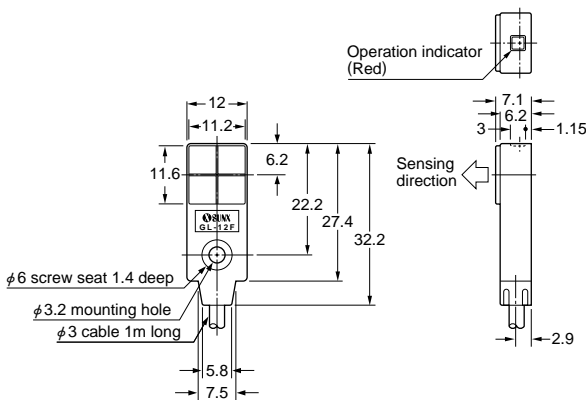

MS-GL12 × 10 Sensor mounting bracket (Optional)

Mounting hole dimensions

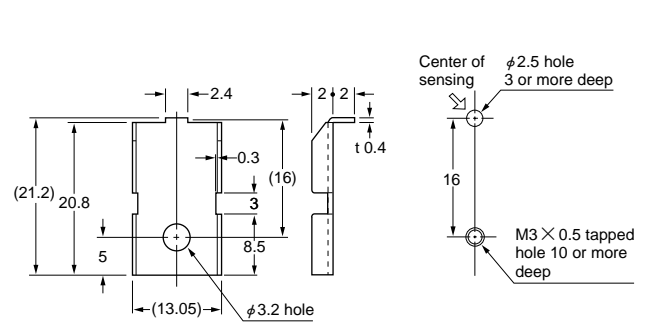

Material: Cold rolled carbon steel (SPCC)
(Nickel plated)

1 No. each of M3 (length 12mm) pan head screw, plain washer, spring washer and rubber washer ($\phi 9.5 \times t 0.5\text{mm}$) is attached.

GXL

GL-6

GL-8U

Amplifier Built-in Type

GL-N12
GL-18H/18HL

GX-U

GX-N

GX

Amplifier-separated Type
GA-10/GH