

GX-U SERIES

DC 2-wire Cylindrical Inductive Proximity Sensor

GXL

GL-6

GL-8U

GL-N12

GL-18H/18HL

GX-U

GX-N

GX

GA-10/GH

Amplifier Built-in Type

Amplifier-separated Type

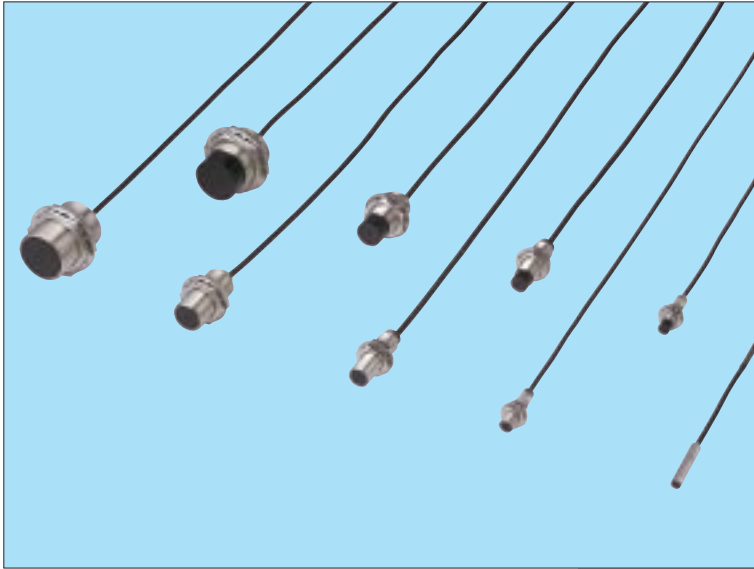

High Performance
&
Ease of Use

CE Marked
Conforming to EMC Directive

Robust in Tightening

The tightening torque has been improved to approx. four times greater than that of conventional models because of its thick case. As the sensor can be securely tightened, it does not get loose due to vibration or shock.

GX-18M(B) Conventional model		GX-18MU(B)
19.6N·m or less	→ 4 times approx. →	80N·m or less



Compact Size: $\phi 5.4\text{mm}$

GX-5SU(B) is just 5.4mm in diameter, the smallest in existing DC two-wire sensors. It saves you space.

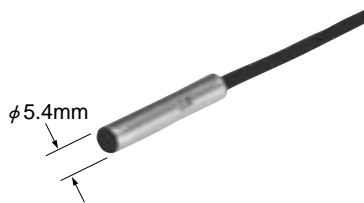

Long Sensing Range

The **GX-U** series features 1.6 times longer sensing range than conventional models. As it can be mounted at a sufficient distance from the object, there is no fear of the sensor and the object colliding.

GX-12MLU(B)

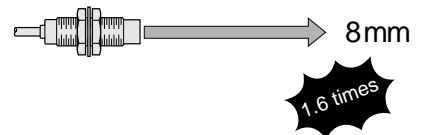

GX-12ML(B) Conventional model



2-color Indicator

The normally open type is equipped with a 2-color indicator. (The normally closed type has the operation indicator instead.) The operation is easily observable from any direction because the entire sensor tail lights up.



Simple Wiring

The wiring cost is considerably reduced as it is DC 2-wire type. Further, each of **GX-12MU(B)**, **GX-18MU(B)**, **GX-30MU(B)** is available as a pigtailed model (300mm long cable with attached connector) that makes replacement easy and quick.

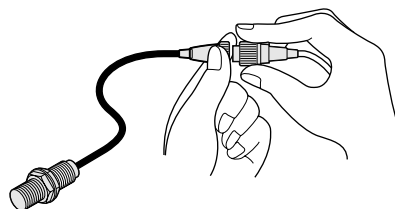

Spatter-resistant Type Available

As the enclosure is entirely coated by fluorine resin, the sensor can be safely used at a place where welding spatters fly around. Both the pigtail cable and the mating cable are also spatter-resistant.



APPLICATIONS

Detecting traveling aluminum pallets

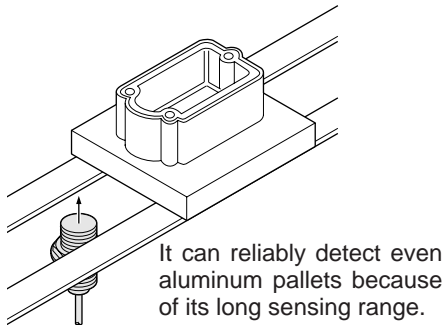

Controlling depth of drilling

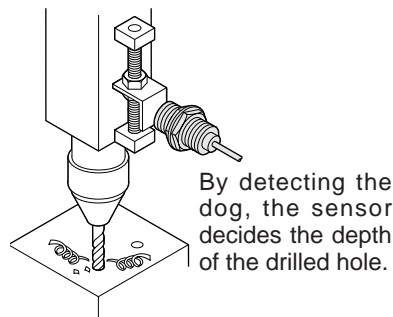

Positioning object at welding station (GX-F□U-J only)

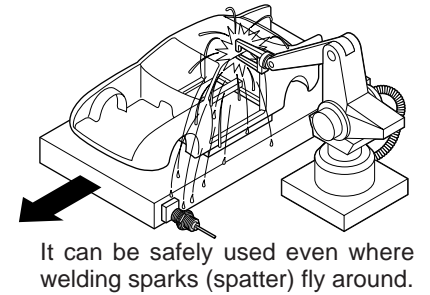

ORDER GUIDE

Standard type

Type	Appearance (mm)	Sensing range (Note)	Model No.	Output operation		
Shielded type	Non-threaded type 	1.5mm ← Maximum operation distance (0 to 1.2mm) ← Stable sensing range	GX-5SU	Normally open		
			GX-5SUB	Normally closed		
	Threaded type	M8 	2mm (0 to 1.6mm)	GX-8MU	Normally open	
				GX-8MUB	Normally closed	
		M12 	3mm (0 to 2.4mm)	GX-12MU	Normally open	
				GX-12MUB	Normally closed	
			M18 	7mm (0 to 5.6mm)	GX-18MU	Normally open
		GX-18MUB		Normally closed		
	Non-shielded type	Threaded type	M30 	10mm (0 to 8mm)	GX-30MU	Normally open
					GX-30MUB	Normally closed
Threaded type		M8 	4mm (0 to 3.2mm)	GX-8MLU	Normally open	
				GX-8MLUB	Normally closed	
		M12 	8mm (0 to 6.4mm)	GX-12MLU	Normally open	
				GX-12MLUB	Normally closed	
		M18 	15mm (0 to 12mm)	GX-18MLU	Normally open	
				GX-18MLUB	Normally closed	
		M30 	22mm (0 to 17.6mm)	GX-30MLU	Normally open	
				GX-30MLUB	Normally closed	

Note: The maximum operation distance stands for the maximum distance for which the sensor can detect the standard sensing object.
The stable sensing range stands for the sensing range for which the sensor can stably detect the standard sensing object even if there is an ambient temperature drift and/or supply voltage fluctuation.

GXL

GL-6

GL-8U

Amplifier Built-in Type

GL-N12

GL-18H/18HL

GX-U

GX-N

GX

Amplifier-separated Type

GA-10/GH

GX-U

ORDER GUIDE

Pigtailed type

Pigtailed sensors are optionally available. [Standard type is cable type. However, there are no pigtail options for GX-5SU(B), GX-8MU(B), or GX-8MLU(B).] When ordering this type, add suffix '-J' to the model No. (e.g.) The pigtail type of GX-12MLUB is 'GX-12MLUB-J'.

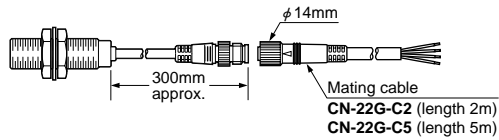

Spatter-resistant type

Type	Appearance (mm)	Sensing range (Note)	Model No.	Output operation
Shielded type Threaded type		3mm ← Maximum operation distance (0 to 2.4mm) ← Stable sensing range	GX-F12MU-J	Normally open
		7mm (0 to 5.6mm)	GX-F18MU-J	
		10mm (0 to 8mm)	GX-F30MU-J	

Note: The maximum operation distance stands for the maximum distance for which the sensor can detect the standard sensing object.
The stable sensing range stands for the sensing range for which the sensor can stably detect the standard sensing object even if there is an ambient temperature drift and/or supply voltage fluctuation.

• Mating cable

Model No.	Description	
CN-22G-C2	Length: 2m	0.3mm ² 2-core flame-resistant, spatter-resistant cable (outer dia ϕ 3.6mm) with connector at one end
CN-22G-C5	Length: 5m	

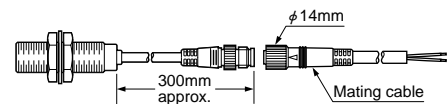

OPTIONS

Designation	Model No.	Description	
Sensor mounting bracket	MS-SS5	For GX-5SU(B)	The sensor is easily mounted with this bracket.
Protection cover	MS-H12	For GX-12MU(B)	It protects the sensing surface from welding sparks (spatter), etc.
	MS-H18	For GX-18MU(B)	
	MS-H30	For GX-30MU(B)	

Sensor mounting bracket

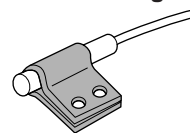

Protection cover

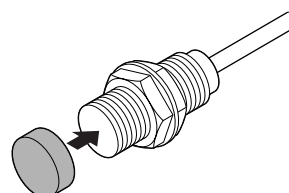

SPECIFICATIONS

Standard type

Item	Model No.	Type	Shielded type					Non-shielded type			
			Non-threaded type	Threaded type				Threaded type			
				Normally open	GX-5SU	GX-8MU	GX-12MU	GX-18MU	GX-30MU	GX-8MLU	GX-12MLU
		Normally closed	GX-5SUB	GX-8MUB	GX-12MUB	GX-18MUB	GX-30MUB	GX-8MLUB	GX-12MLUB	GX-18MLUB	GX-30MLUB
Max. operation distance (Note 1)			1.5mm ± 10%	2mm ± 10%	3mm ± 10%	7mm ± 10%	10mm ± 10%	4mm ± 10%	8mm ± 10%	15mm ± 10%	22mm ± 10%
Stable sensing range (Note 1)			0 to 1.2mm	0 to 1.6mm	0 to 2.4mm	0 to 5.6mm	0 to 8mm	0 to 3.2mm	0 to 6.4mm	0 to 12mm	0 to 17.6mm
Standard sensing object			Iron sheet 6 X 6 X 1mm	Iron sheet 8 X 8 X 1mm	Iron sheet 12 X 12 X 1mm	Iron sheet 18 X 18 X 1mm	Iron sheet 30 X 30 X 1mm	Iron sheet 20 X 20 X 1mm	Iron sheet 30 X 30 X 1mm	Iron sheet 50 X 50 X 1mm	Iron sheet 70 X 70 X 1mm
Hysteresis			20% or less of operation distance								
Supply voltage			12 to 24V DC $\pm \frac{10}{15}\%$ Ripple P-P 10% or less								
Current consumption (Note 2)			0.8mA or less								
Output			Non-contact DC 2-wire type • Load current: 3 to 70mA (Note 3) • Residual voltage: 3V or less (Note 4)								
		Utilization category	DC-12 or DC-13								
		Short-circuit protection	Incorporated								
Max. response frequency			1.7kHz	1.2kHz	1.2kHz	500Hz	350Hz	1kHz	650Hz	350Hz	220Hz
Operation indicator			Normally closed type: Orange LED (lights up when the output is ON)								
2-color indicator			Normally open type: Lights up in green under stable sensing condition, lights up in orange under unstable sensing condition								
Environmental resistance		Pollution degree	3 (Industrial environment)								
		Protection	IP67 (IEC), IP67g (JEM)								
		Ambient temperature	- 25 to + 70°C, Storage: - 30 to + 80°C								
		Ambient humidity	45 to 85% RH, Storage: 35 to 95% RH								
		EMC	Emission: EN50081-2, Immunity: EN50082-2								
		Voltage withstandability	1,000V AC for one min. between all supply terminals connected together and enclosure								
		Insulation resistance	50MΩ, or more, with 250V DC megger between all supply terminals connected together and enclosure								
		Vibration resistance	10 to 55Hz frequency, 1.5mm amplitude in X, Y and Z directions for two hours each								
	Shock resistance	1,000m/s ² acceleration (100G approx.) in X, Y and Z directions for three times each									
Sensing range variation		Temperature characteristics	Over ambient temperature range - 25 to + 70°C: within ± 10% of sensing range at 20°C								
		Voltage characteristics	Within ± 2% for ± 10% fluctuation of the supply voltage								
Material			Enclosure: Brass (Nickel plated) [However, SUS303 (stainless steel) for GX-5SU(B), GX-8MU(B) and GX-8MLU(B)] Sensing parts: Nylon [However, polyacetalate for GX-5SU(B)], Indicator part: Nylon [excluding GX-5SU(B)]								
Cable			0.3mm ² [0.15mm ² for GX-5SU(B), GX-8MU(B) and GX-8MLU(B)] 2-core oil, heat and cold resistant cabtyre cable, 2m long								
Cable extension			Extension up to total 50m is possible with 0.3mm ² , or more, cable.								
Weight (Note 5)			20g approx.	30g approx.	55g approx.	95g approx.	220g approx.	30g approx.	55g approx.	95g approx.	220g approx.
Accessories			Nut: 2 Nos., Toothed lock washer: 1 No.								

- Notes: 1) The maximum operation distance stands for the maximum distance for which the sensor can detect the standard sensing object.
The stable sensing range stands for the sensing range for which the sensor can stably detect the standard sensing object even if there is an ambient temperature drift and/or supply voltage fluctuation.
- 2) It is the leakage current when the output is in the OFF state.
- 3) The maximum load current varies with the ambient temperature. Refer to 'I/O CIRCUIT AND WIRING DIAGRAMS' for more details.
- 4) When the cable is extended, the residual voltage becomes larger.
- 5) The weight of the threaded type includes the weight of two nuts and one toothed lock washer.

Spatter-resistant type

Item	Model No.	Type	Shielded type		
			Threaded type		
			Normally open	GX-F12MU-J	GX-F18MU-J
Material			Enclosure: Brass (Fluorine resin coated), Sensing part: Polyacetalate (Fluorine resin coated), Indicator part: Polyacetalate		
Cable			0.3mm ² 2-core spatter-resistant cable, 300mm long with round type connector		
Cable extension			Extension up to total 50m is possible with 0.3mm ² , or more, cable.		
Weight (Note)			35g approx.	75g approx.	200g approx.
Accessories			Nut: 2 Nos. (Fluorine resin coated), Toothed lock washer: 1 No. (Fluorine resin coated)		

The specifications other than the above-mentioned are identical to that of the standard type.

Note: The given weight includes the weight of two nuts and one toothed lock washer.

GX-U

I/O CIRCUIT AND WIRING DIAGRAMS

GX-□U(B)

I/O circuit diagram

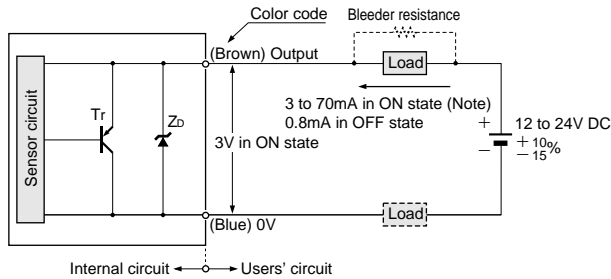

Symbols ... Z_d: Surge absorption zener diode
Tr: PNP output transistor

Note: The maximum load current varies depending on the ambient temperature.

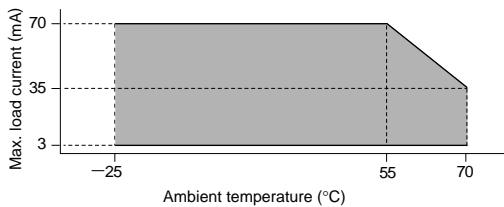

Wiring diagram

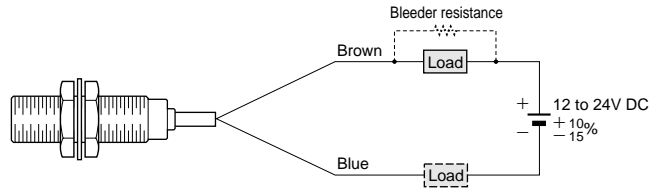

Conditions for the load

- 1) The load should not be actuated by the leakage current (0.8mA) in the OFF state.
- 2) The load should be actuated by (supply voltage - 3V) in the ON state.
- 3) The current in the ON state should be between 3 to 70mA DC.
[In case the current is less than 3mA, connect a bleeder resistance]
[in parallel to the load so that a current of 3mA, or more, flows.]

GX-F□U-J

I/O circuit diagram

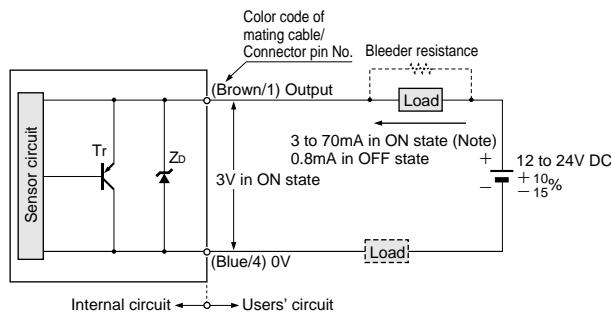

Symbols ... Z_d: Surge absorption zener diode
Tr: PNP output transistor

Note: The maximum load current varies depending on the ambient temperature.

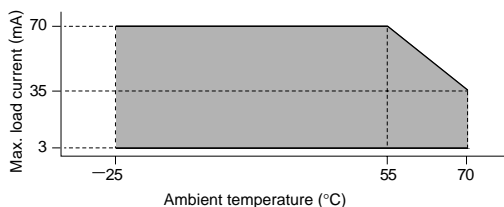

Wiring diagram

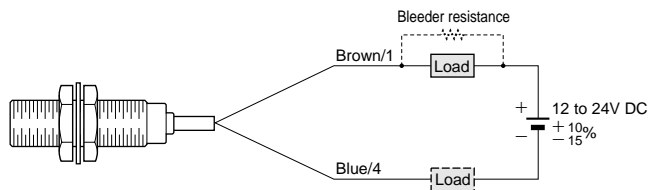

Conditions for the load

- 1) The load should not be actuated by the leakage current (0.8mA) in the OFF state.
- 2) The load should be actuated by (supply voltage - 3V) in the ON state.
- 3) The current in the ON state should be between 3 to 70mA DC.
[In case the current is less than 3mA, connect a bleeder resistance]
[in parallel to the load so that a current of 3mA, or more, flows.]

Connector pin position

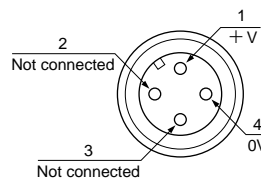

I/O CIRCUIT AND WIRING DIAGRAMS

GX-□U(B)-J

I/O circuit diagram

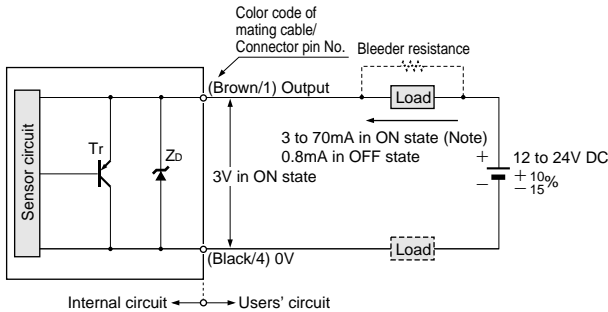

Symbols ... Z_D: Surge absorption zener diode
Tr: PNP output transistor

Note: The maximum load current varies depending on the ambient temperature.

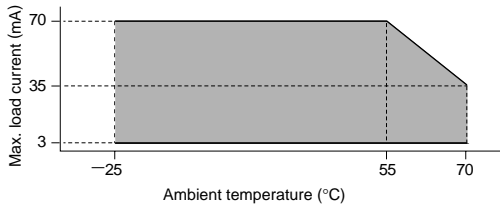

Wiring diagram

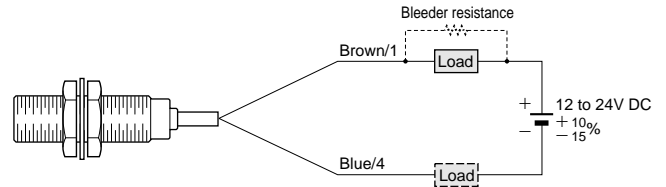

Conditions for the load

- 1) The load should not be actuated by the leakage current (0.8mA) in the OFF state.
- 2) The load should be actuated by (supply voltage - 3V) in the ON state.
- 3) The current in the ON state should be between 3 to 70mA DC.
[In case the current is less than 3mA, connect a bleeder resistance in parallel to the load so that a current of 3mA, or more, flows.]

Connector pin position

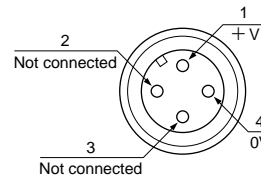

SENSING CHARACTERISTICS (TYPICAL)

GX-5SU GX-5SUB

Sensing field

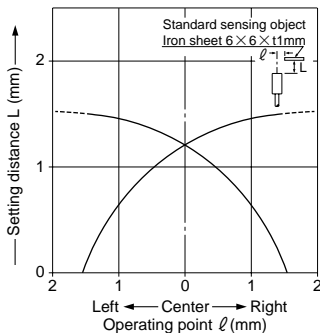

Correlation between sensing object size and sensing range

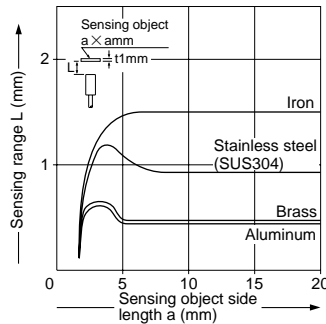

As the sensing object size becomes smaller than the standard size (iron sheet 6 × 6 × 1mm), the sensing range shortens as shown in the left figure.

GXL

GL-6

GL-8U

Amplifier Built-in Type
GL-18H/18HL
GL-N12

GX-U

GX-N

GX

Amplifier-separated Type
GA-10/GH

GX-U

SENSING CHARACTERISTICS (TYPICAL)

GXL

GL-6

GL-8U

GL-N12

GL-18H/18HL
Amplifier Built-in Type

GX-U

GX-N

GX

GA-10/GH
Amplifier-separated Type

GX-8MU GX-8MUB

Sensing field

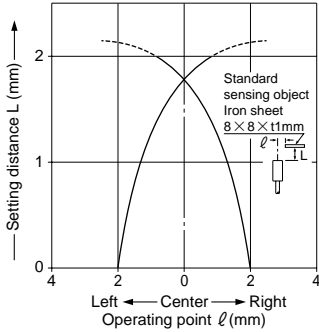

Correlation between sensing object size and sensing range

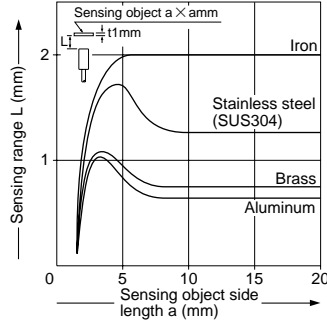

As the sensing object size becomes smaller than the standard size (iron sheet 8 × 8 × t1mm), the sensing range shortens as shown in the left figure.

GX-12MU GX-12MUB GX-F12MU-J

Sensing field

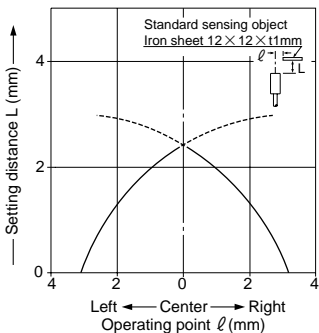

Correlation between sensing object size and sensing range

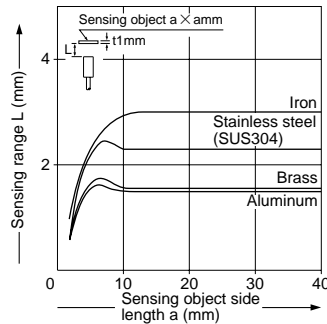

As the sensing object size becomes smaller than the standard size (iron sheet 12 × 12 × t1mm), the sensing range shortens as shown in the left figure.

GX-18MU GX-18MUB GX-F18MU-J

Sensing field

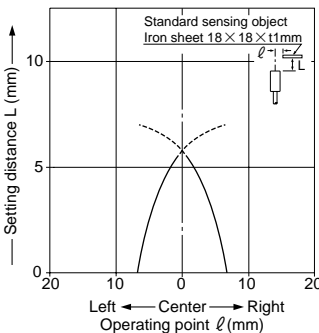

Correlation between sensing object size and sensing range

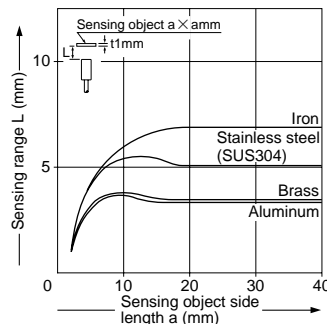

As the sensing object size becomes smaller than the standard size (iron sheet 18 × 18 × t1mm), the sensing range shortens as shown in the left figure.

GX-30MU GX-30MUB GX-F30MU-J

Sensing field

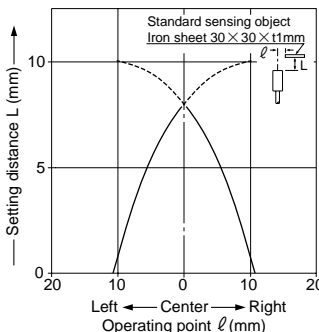

Correlation between sensing object size and sensing range

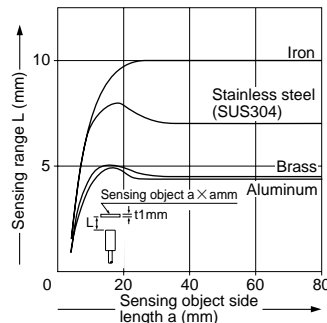

As the sensing object size becomes smaller than the standard size (iron sheet 30 × 30 × t1mm), the sensing range shortens as shown in the left figure.

SENSING CHARACTERISTICS (TYPICAL)

GX-8MLU GX-8MLUB

Sensing field

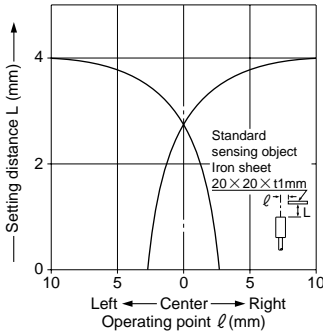

Correlation between sensing object size and sensing range

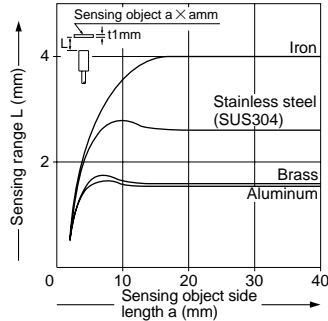

As the sensing object size becomes smaller than the standard size (iron sheet $20 \times 20 \times 1\text{mm}$), the sensing range shortens as shown in the left figure.

GX-12MLU GX-12MLUB

Sensing field

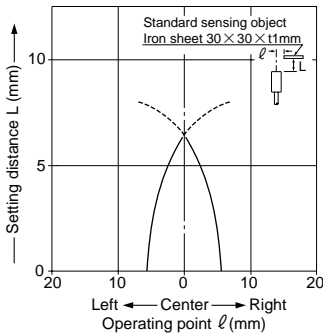

Correlation between sensing object size and sensing range

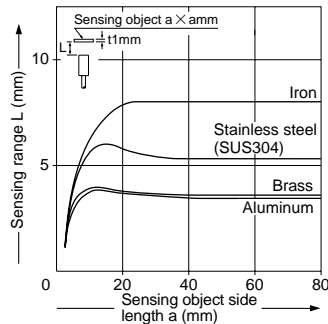

As the sensing object size becomes smaller than the standard size (iron sheet $30 \times 30 \times 1\text{mm}$), the sensing range shortens as shown in the left figure.

GX-18MLU GX-18MLUB

Sensing field

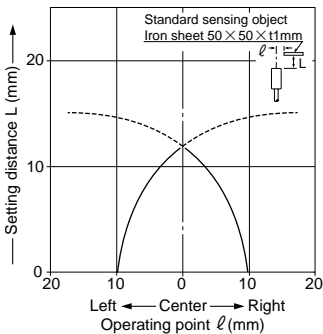

Correlation between sensing object size and sensing range

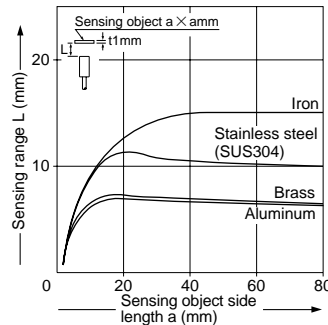

As the sensing object size becomes smaller than the standard size (iron sheet $50 \times 50 \times 1\text{mm}$), the sensing range shortens as shown in the left figure.

GX-30MLU GX-30MLUB

Sensing field

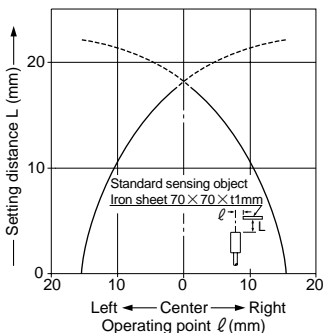

Correlation between sensing object size and sensing range

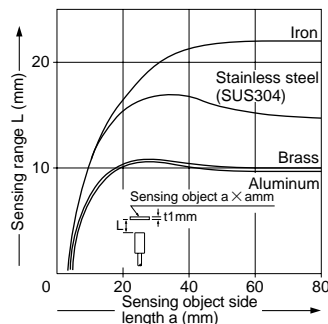

As the sensing object size becomes smaller than the standard size (iron sheet $70 \times 70 \times 1\text{mm}$), the sensing range shortens as shown in the left figure.

GXL

GL-6

GL-8U

Amplifier Built-in Type
GL-18H/18HL

GL-N12

GX-U

GX-N

GX

Amplifier-separated Type
GA-10/GH

GX-U

PRECAUTIONS FOR PROPER USE

Refer to P.836~ for general precautions.



This product is not a safety sensor. Its use is not intended or designed to protect life and prevent body injury or property damage from dangerous parts of machinery. It is a normal object detection sensor.

Mounting

- The tightening torque should be under the value given below.

Mounting with a set screw

- Tighten with the cup-point of a set screw (M4 or less).

<Non-threaded type>

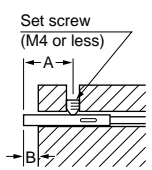

Model No.	A(mm)	B(mm)	Tightening torque
GX-5SU(B)	5 to 30	3	0.78N·m

- Do not fix on the operation indicator or opposite to it.

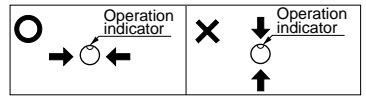
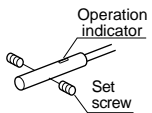

Mounting with nut

<Shielded threaded type>

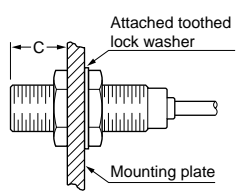

<Non-shielded threaded type>

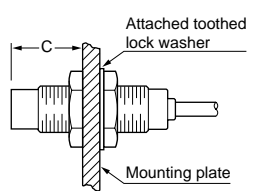

Model No.	Dimension C (mm)	Tightening torque
GX-8MU(B)	3 to 10.3	5.9N·m
	10.3 or more	11.8N·m
GX-12MU(B) GX-F12MU-J	3.5 to 13.5	10N·m
	13.5 or more	20N·m
GX-18MU(B) GX-F18MU-J	4 to 18	45N·m
	18 or more	80N·m
GX-30MU(B) GX-F30MU-J	5 to 21	80N·m
	21 or more	180N·m
GX-8MLU(B)	12 or more	11.8N·m
GX-12MLU(B)	15 or more	20N·m
GX-18MLU(B)	25 or more	80N·m
GX-30MLU(B)	30 or more	180N·m

Note: Mount such that the nuts do not protrude from the threaded portion.

Distance from surrounding metal

- As metal around the sensor may affect the sensing performance, pay attention to the following points.

Influence of surrounding metal

- The surrounding metal will affect the sensing performance. Keep the minimum distance specified in the table below.

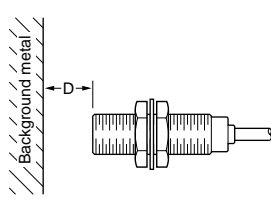

Model No.	D(mm)
GX-5SU(B)	4.5
GX-8MU(B)	4.5
GX-12MU(B) GX-F12MU-J	8
GX-18MU(B) GX-F18MU-J	20
GX-30MU(B) GX-F30MU-J	40
GX-8MLU(B)	8
GX-12MLU(B)	22
GX-18MLU(B)	45
GX-30MLU(B)	75

Embedding of the sensor in metal

- Sensing range may decrease if the sensor is completely embedded in metal. Especially for the non-threaded type and the non-shielded type, keep the minimum distance specified in the table below.

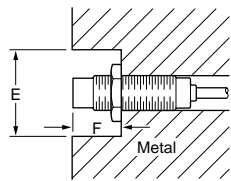

Model No.	E(mm)	F(mm)
GX-5SU(B)	φ12	3
GX-8MLU(B)	φ24	12
GX-12MLU(B)	φ50	15
GX-18MLU(B)	φ75	25
GX-30MLU(B)	φ105	30

Note: With the non-shielded type, the sensing range may vary depending on the position of the nuts.

Mutual interference

- When two or more sensors are installed in parallel or face to face, keep the minimum separation distance specified below to avoid mutual interference.

Face to face mounting

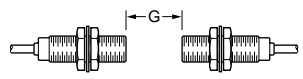

Model No.	G(mm)	H(mm)
GX-5SU(B)	19	14
GX-8MU(B)	20	15
GX-12MU(B) GX-F12MU-J	35	20
GX-18MU(B) GX-F18MU-J	70	45
GX-30MU(B) GX-F30MU-J	115	70
GX-8MLU(B)	60	45
GX-12MLU(B)	145	95
GX-18MLU(B)	250	165
GX-30MLU(B)	350	250

Parallel mounting

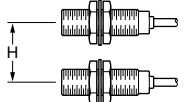

PRECAUTIONS FOR PROPER USE

Refer to P.836~ for general precautions.

Sensing range

- The sensing range is specified for the standard sensing object. With a non-ferrous metal, the sensing range is obtained by multiplying with the correction coefficient specified below.

Correction coefficient

Model No. \ Metal	Iron	Stainless steel (SUS304)	Brass	Aluminum
GX-5SU(B)	1	0.63 approx.	0.32 approx.	0.30 approx.
GX-8MU(B)	1	0.59 approx.	0.32 approx.	0.29 approx.
GX-12MU(B) GX-F12MU-J	1	0.75 approx.	0.51 approx.	0.49 approx.
GX-18MU(B) GX-F18MU-J	1	0.75 approx.	0.50 approx.	0.48 approx.
GX-30MU(B) GX-F30MU-J	1	0.69 approx.	0.44 approx.	0.42 approx.
GX-8MLU(B)	1	0.64 approx.	0.38 approx.	0.38 approx.
GX-12MLU(B)	1	0.67 approx.	0.44 approx.	0.43 approx.
GX-18MLU(B)	1	0.68 approx.	0.45 approx.	0.43 approx.
GX-30MLU(B)	1	0.67 approx.	0.44 approx.	0.43 approx.

Note: The sensing range also changes if the sensing object is plated.

Protection cover (Optional)

- It protects the sensing surface from welding sparks (spatter), etc.

Mounting method

Protection cover

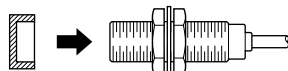

Material: Fluorine resin

Note: Mount the protection cover so that there is no gap between it and the sensing surface.

Sensor

Model No.	Applicable model No.
MS-H12	GX-12MU(B)
MS-H18	GX-18MU(B)
MS-H30	GX-30MU(B)

Others

- Do not use during the initial transient time (50ms) after the power supply is switched on.
- When the sensor is mounted on a moving base, stress should not be applied to the sensor cable joint.

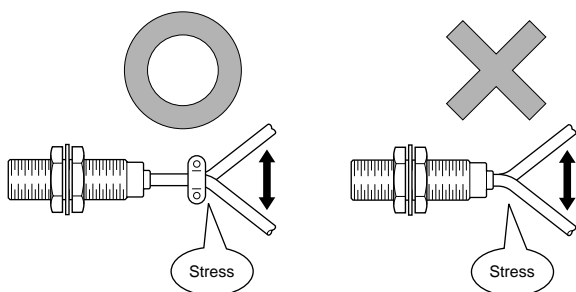

Wiring

- The sensor must be connected to a power supply via a load. If the sensor is connected to a power supply without a load, the short-circuit protection makes the sensor inoperable. (The output stays in the OFF state and the indicator does not light up.) In this case, rectify by connecting the power supply via a load. Now, the sensor becomes operable. Further, take care that if the power supply is connected with reverse polarity without a load, the sensor will get damaged.

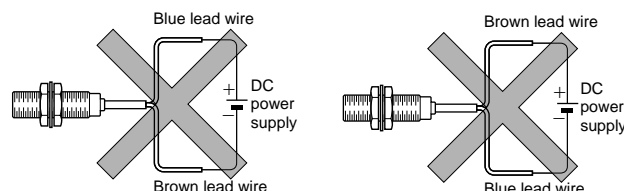

- For series connection (AND circuit) or parallel connection (OR circuit) of sensors, take care of the following.

Series connection (AND circuit)

When all sensors are in the ON state, the load voltage V_{RL} is given by:

$$V_{RL} = V_{CC} - n \times 3(V)$$

V_{CC} : supply voltage (24V DC max.)
 n : number of sensors

Make sure that the load can work properly at this voltage.

Note: The output is generated normally even if the indicator does not light up properly.

Parallel connection (OR circuit)

When all sensors are in the OFF state, the load leakage current I_{CC} is given by:

$$I_{CC} = n \times 0.8(\text{mA}) \quad (n: \text{number of sensors})$$

Make sure that the load can work properly.

Note: The load current in the ON state is given by:

$$I_L = \frac{V_{CC} - 3V}{\text{Load resistance}} \quad (\text{mA})$$

The load current must be $3\text{mA} \times n \leq I_L \leq 70\text{mA}$ (n : number of sensors turned ON)

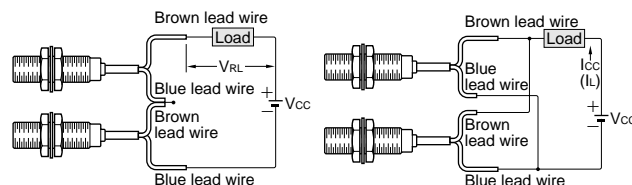

- The residual voltage of the sensor is 3V. Before connecting a relay as the load, take care of its actuation voltage. (Some 12V relays may not be usable.)

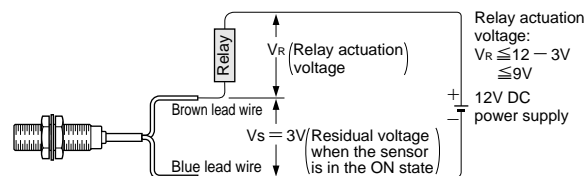

2-color indicator (Normally open type only)

- When the sensing object is in the stable sensing range, the LED lights up in green, and when the sensing object is in the unstable sensing range, the LED lights up in orange. While the LED lights up in green, the sensing is performed stably without being affected by temperature drifts or voltage fluctuations.

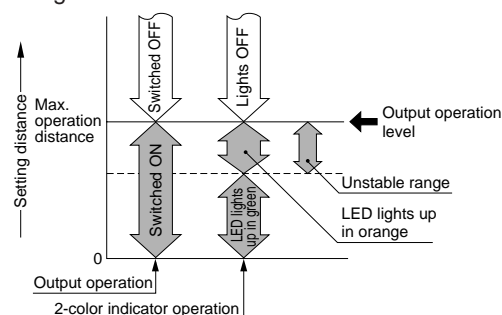

GX-U

DIMENSIONS (Unit: mm)

**GX-5SU
GX-5SUB** Sensor

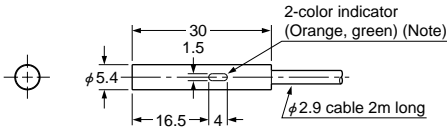

Note: Normally closed type has an operation indicator (orange) instead of the 2-color indicator.

**GX-8MU
GX-8MUB** Sensor

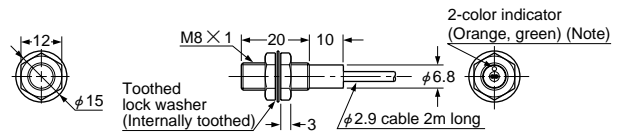

Note: Normally closed type has an operation indicator (orange) instead of the 2-color indicator.

**GX-12MU
GX-12MUB** Sensor

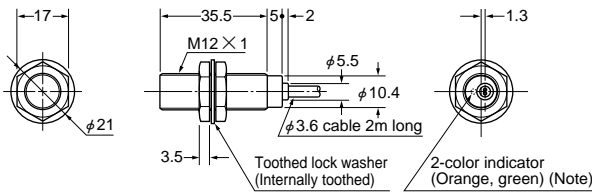

Note: Normally closed type has an operation indicator (orange) instead of the 2-color indicator.

**GX-18MU
GX-18MUB** Sensor

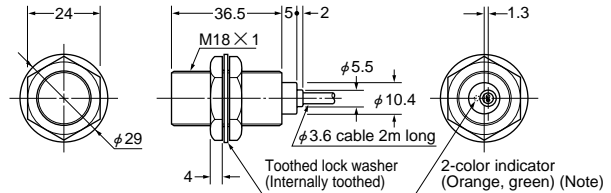

Note: Normally closed type has an operation indicator (orange) instead of the 2-color indicator.

**GX-30MU
GX-30MUB** Sensor

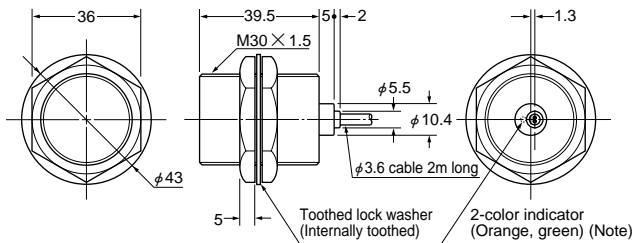

Note: Normally closed type has an operation indicator (orange) instead of the 2-color indicator.

**GX-8MLU
GX-8MLUB** Sensor

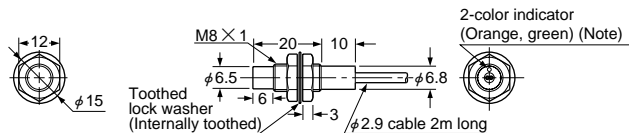

Note: Normally closed type has an operation indicator (orange) instead of the 2-color indicator.

**GX-12MLU
GX-12MLUB** Sensor

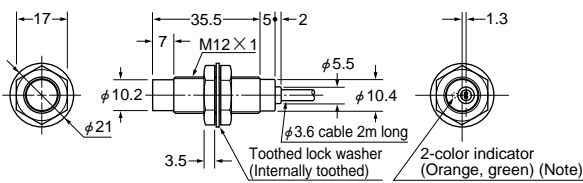

Note: Normally closed type has an operation indicator (orange) instead of the 2-color indicator.

**GX-18MLU
GX-18MLUB** Sensor

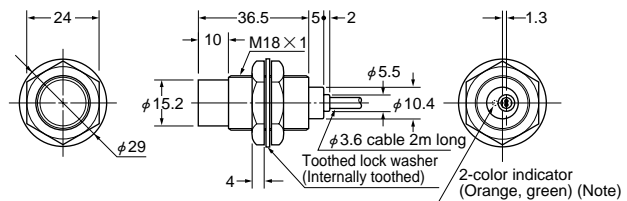

Note: Normally closed type has an operation indicator (orange) instead of the 2-color indicator.

**GX-30MLU
GX-30MLUB** Sensor

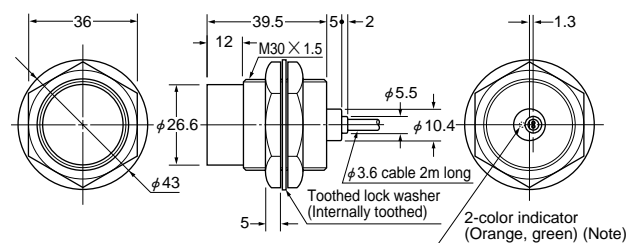

Note: Normally closed type has an operation indicator (orange) instead of the 2-color indicator.

GX-F12MU-J Sensor

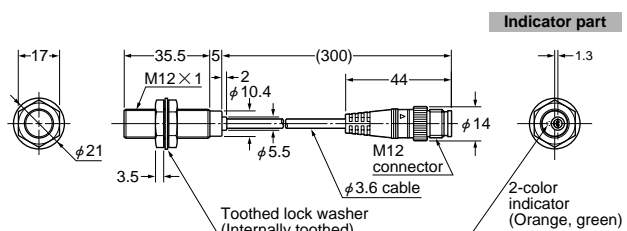

DIMENSIONS (Unit: mm)

GX-F18MU-J Sensor

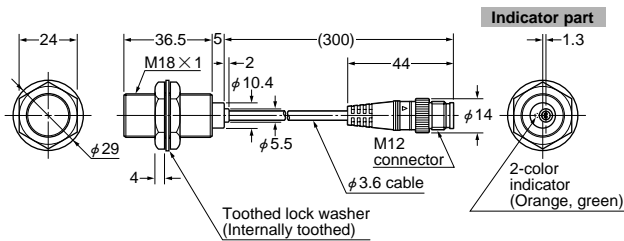

GX-F30MU-J Sensor

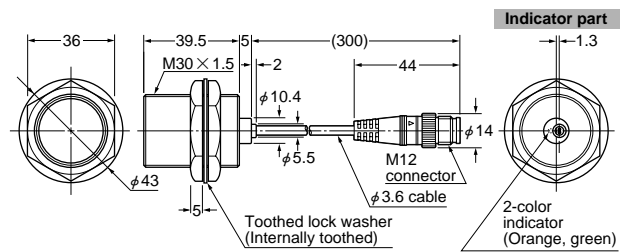

MS-SS5 Sensor mounting bracket for GX-5SU(B) (Optional)

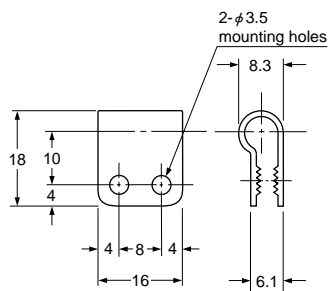

Material: Nylon 66

MS-H12 MS-H18 MS-H30 Protection cover (Optional)

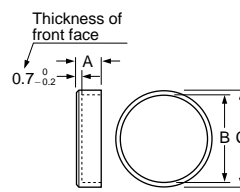

Material: Fluorine resin

Symbol	A	B	C	Applicable model No.
Model No.				
MS-H12	5	φ11.5	φ14	GX-12MU(B)
MS-H18	6	φ17.5	φ20	GX-18MU(B)
MS-H30	8	φ29.4	φ33	GX-30MU(B)

GXL

GL-6

GL-8U

Amplifier Built-in Type

GX-U

GX-N

GX

Amplifier-separated Type

GA-10/GH